



 **MAXI-COSI**[®]
We carry the future



Pria Max

3-in-1 Convertible Car Seat

4358-7944
5.27.20



KEEP INSTRUCTIONS FOR FUTURE USE.
Read all instructions before using this car seat.
WARNING ⚠ Failure to follow the warnings on the labels and in the instruction manual can result in serious injury or death to your child.

Overview

Welcome to the Maxi-Cosi family and thank you for choosing this car seat, also known as a child restraint!

To help you get started using your child's new car seat, here are the 4 main tasks you'll need to complete.

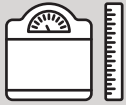

Measure Your Child



Adjust the Car Seat to Fit Your Child



Install the Car Seat into Your Vehicle



Secure Your Child in the Car Seat

Your child's safety is worth the time it will take to read and follow these instructions.

Ready? Let's go!

Pages 1-5 will introduce you to the parts of the car seat.

Page 78 has our contact information. If at any point you would like assistance, please feel free to reach out to us.

Quick Navigation

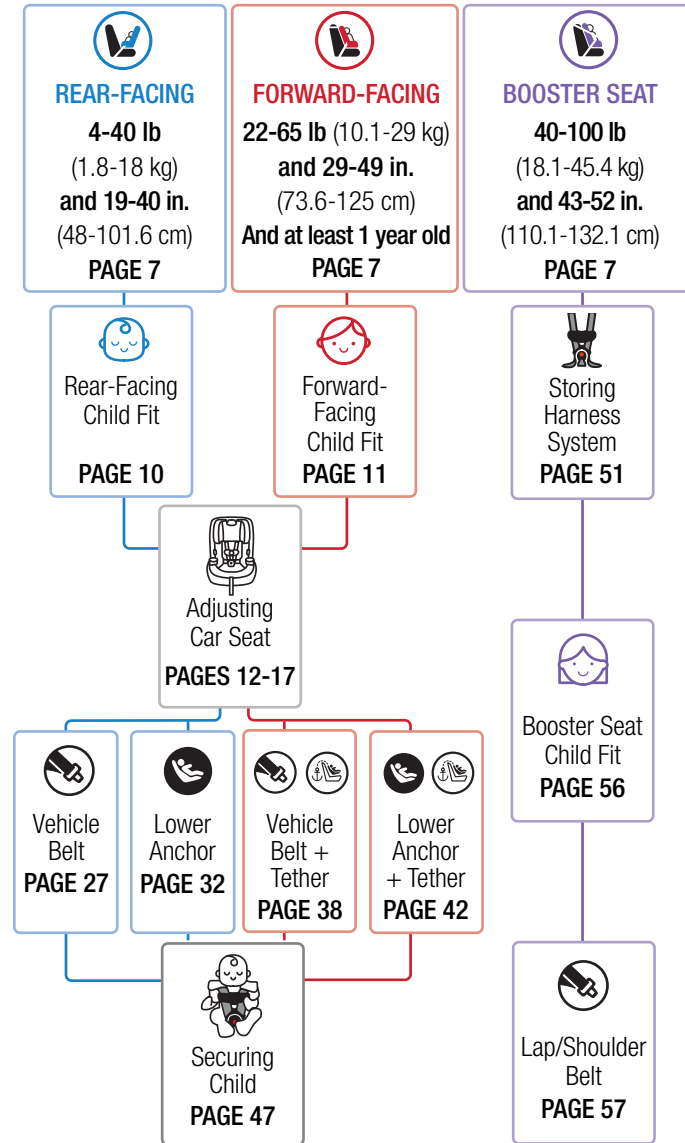

Contents

Getting Started

Parts of the Car Seat	1
Accessory Use	3
Choosing Car Seat Mode	6
Preparing Car Seat for Child Fit	8
Rear-Facing Child Fit	10
Forward-Facing Child Fit	11

Making Adjustments to Car Seat

Changing Headrest/Harness Height	12
Changing Buckle Position	13
Buckle Adjustment for Smaller Infants	16
Reclining the Car Seat	17

Choosing LATCH or Vehicle Belt

LATCH: Lower Anchor Use	18
Vehicle Belts	20
Tether Use	24

Installation in Vehicle

Rear-Facing Mode	26
Rear-Facing Vehicle Belt Install	27
Rear-Facing LATCH: Lower Anchor Install	32
Forward-Facing Mode	37
Forward-Facing Vehicle Belt + Tether Install	38
Forward-Facing LATCH: Lower Anchor + Tether Install	42

Securing Child in Car Seat..... 47

Booster Seat

Booster Seat Mode	50
Storing Harness System	51
Booster Seat Child Fit	56
Lap/Shoulder Belt Use	57

Wash and Care of Car Seat Parts

Removing Seat Pad Set for Cleaning	59
Cleaning Parts of Car Seat and Installing Seat Pad Set	62
Installing Harness System	65

Safety Information

Aircraft Information	70
Replacement and Expiration of Car Seat	71
Child Restraint Use	72
Installation in Vehicle	72
Vehicle Seating Position	73
Registration and Safety Notices	74

Additional Information

Warranty	75
Troubleshooting	76
Replacement Parts List	77
Dorel Juvenile Group Information	78

Parts of the Car Seat

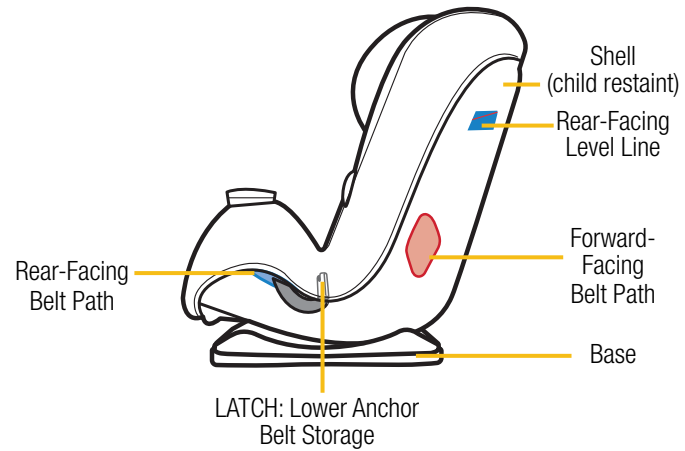
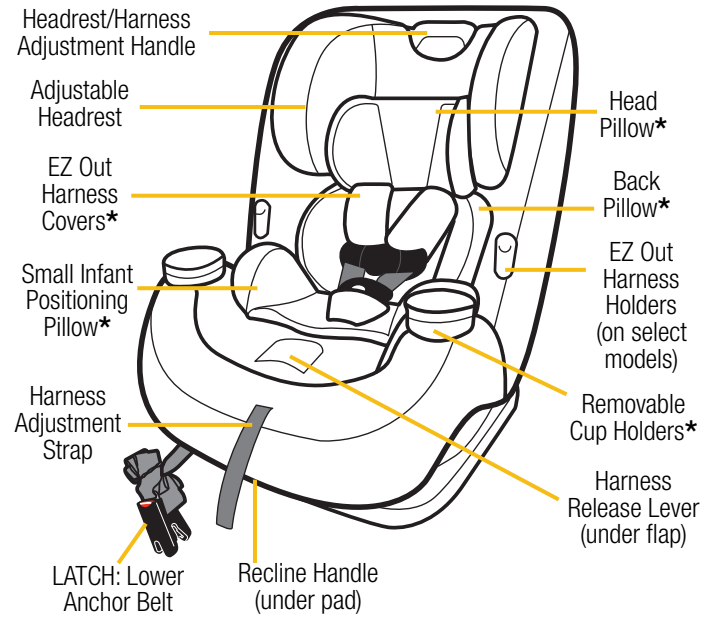

Harness System Detail

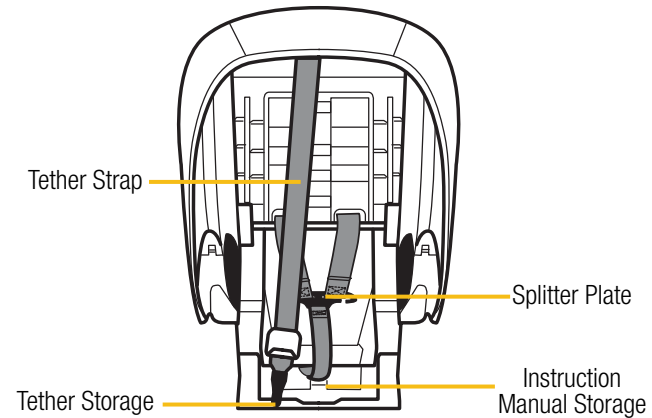
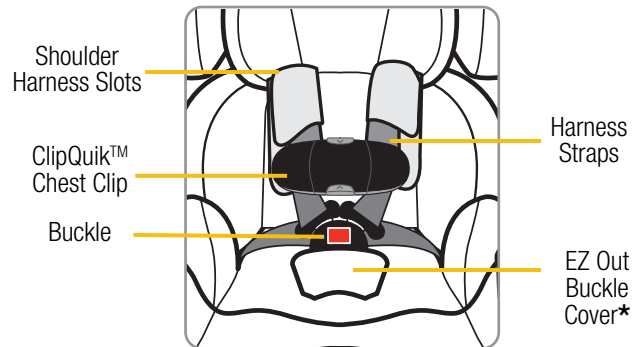

*See pages 3-5 for Accessory Use.



For Use in Rear-Facing or Forward-Facing Mode



Front View



Back View

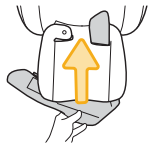

EZ Out Harness Covers

Harness covers help provide comfort to the neck. If the harness covers will not allow proper positioning of the chest clip or interfere with getting a tight enough harness fit for a smaller baby, remove and do not use.

Store until your child is large enough to use these harness covers while maintaining a properly fitting harness.

To remove, undo fasteners on headrest pad. Pull the fastening strips on covers apart. Pull harness straps out of covers. Slide covers out from behind headrest pad.

To install, undo fasteners on headrest. With the back of the harness covers facing you slide covers behind headrest pad. Place harness straps into covers. Fasten harness covers.



EZ Out Buckle Cover

To install, slide buckle into opening in front of buckle cover.

Then be sure to slide buckle cover itself through the buckle slot in only the seat pad.

NOTE: Buckle cover only goes through slot in pad and **not** through buckle slot in shell. It lays flat underneath the pad as shown.

To remove, pull up on buckle cover and slide it off of the buckle and pull it out of the buckle slot in the seat pad.



For Use in All Modes

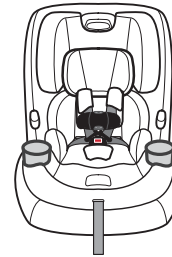

Removable Cup Holders

The cup holders are top-rack dishwasher safe.

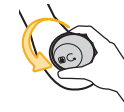

To remove cup holder, twist the cup holder counterclockwise. Pull it out of slot in shell.

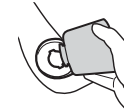

To install cup holder, align tabs on bottom of cup holder with slots in shell. Twist clockwise to lock in place.



For Use in Rear-Facing Mode Only

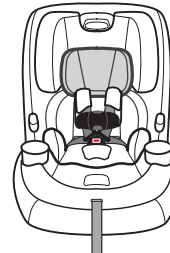

Head and Back Pillow

The head and back pillows must be used together.

To remove head pillow, pull it out from behind the back pillow.



To remove back pillow, loosen the harness straps and slide pillow out from behind the harness straps.

continued on next page



For Use in Rear-Facing Mode Only



Small Infant Positioning Pillow

When using the small infant positioning pillow, you must also use the back and head pillows.

This pillow helps position your infant in the seat in order to achieve proper harness fit.

To determine if the pillow is needed:

1. Place headrest in lowest position.
2. Place infant in car seat without the pillow.
3. Make sure the infant's bottom and back are flat against the car seat.

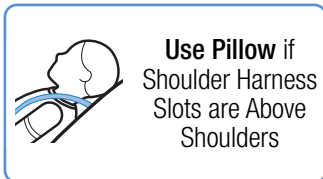

Use Pillow if
Shoulder Harness
Slots are Above
Shoulders



**Do Not Use
Pillow** if Shoulder
Harness Slots are
At or Below
Shoulders

Check often to see how much your infant has grown. Remove the infant pillow once they can sit in the car seat without the infant pillow and the harness slots are **at or below** their shoulders **AND** you can still achieve a snug harness fit.

To learn how to check harness tightness, see pages 47-49.



Measure your child's weight and height (do not guess) before choosing the car seat's mode.

Your child's height, weight, and age determine how the car seat should be placed in the vehicle.

Children vary widely in body size, shape, and temperament—**please consult your doctor before switching between any of these modes within the limits and fit requirements of the seat.**

State Laws

Please be certain to follow your state's laws regarding car seat use.

American Academy of Pediatrics Recommendations

Infants and Toddlers

Should ride in a rear-facing car seat as long as possible, until they reach the highest weight or height allowed by their seat.

Toddlers and Preschoolers

Once they are facing-forward, children should use a forward-facing car seat with a harness for as long as possible, until they reach the height and weight limits for their seats.

School-Aged Children

Once they have outgrown their forward facing car seat, children should use a belt-positioning booster seat until the vehicle's lap and shoulder seat belt fits properly. This is often when they have reached at least 4 feet 9 inches in height and are 8 to 12 years old.

Older Children

All children younger than 13 years should be restrained in the rear seats of vehicles for optimal protection.

continued on next page



REAR-FACING MODE

4-40 lb (1.4-18 kg) and **19-40 in.** (48-101.6 cm)

Children under 1 year of age must ride **Rear-Facing**.

In this car seat, your child can remain **Rear-Facing** until they outgrow any one of the following:

- **Weight Limit:** 40 lb (18 kg); **OR**
- **Height Limit:** 40 in. (101.6 cm); **OR**
- **Rear-Facing** child fit requirements. See page 10.



FORWARD-FACING MODE

22-65 lb (10.1-29 kg) and **29-49 in.** (73.6-125 cm)

Children must be at least 1 year of age to ride **Forward-Facing**.

In this car seat, your child can remain harnessed **Forward-Facing** until they outgrow any one of the following:

- **Weight Limit:** 65 lb (29 kg); **OR**
- **Height Limit:** 49 in. (125 cm); **OR**
- **Forward-Facing** child fit requirements. See page 11.



BOOSTER SEAT MODE

40-100 lb (18.1-45.4 kg)
and **43-52 in.** (110.1-132.1 cm)

In this car seat, your child can remain in a **Booster Seat** until they outgrow any one of the following:

- **Weight Limit:** 100 lb (45.4 kg); **OR**
- **Height Limit:** 52 in. (132.1 cm); **OR**
- **Booster Seat** child fit requirements. See page 56.

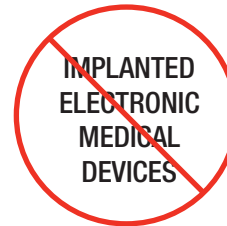

⚠ WARNING: Do not use this chest clip with children who have an implanted electronic medical device.

A magnet is used to help secure the chest clip locking mechanism together which may interfere with the proper function of an implanted electronic medical device.

Parents or caregivers who have an implanted electronic device should keep their device away from the chest clip and consult their doctor and medical device manufacturer for specific information before using this chest clip.

If a parent/caregiver or child has an implanted electronic medical device, please contact Dorel (see page 78) for a replacement (non-magnetic) chest clip free of charge.

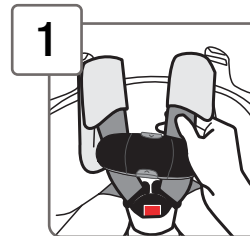

1 Fully Loosen Harness Straps

Place your hand between the harness cover and harness strap.

You may need to undo the harness cover or move the chest clip down.

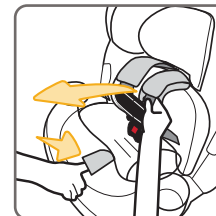

Push down on harness release lever (through opening in pad) while pulling out on harness straps as shown.

continued on next page

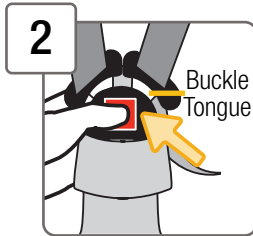

2 Unbuckle Harness

Press in on red button and pull out buckle tongues.

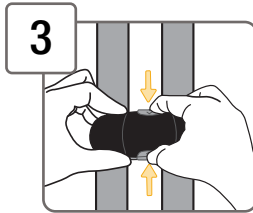

3

Release Chest Clip

Hold the chest clip with both hands and press in on the top and bottom buttons with your index finger and thumb as shown.



While holding the buttons in, pull the right (top) half of the clip apart from the left (bottom) half to release the magnet and separate the chest clip.

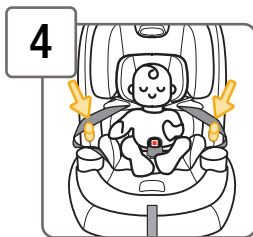

4

Place Harness Straps Out of the Way

You can slide the harness straps behind the EZ Out Harness Holders (on select models) as shown.

Place child in car seat to determine proper harness fit. The child's bottom and back should be flat against the car seat.

For **Rear-Facing** child fit, see page 10.

For **Forward-Facing** child fit, see page 11.

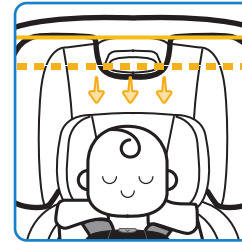

Head Position

The top of your child's head **must be at least 1 in.** (2.5 cm) **below** the top of the car seat's headrest.

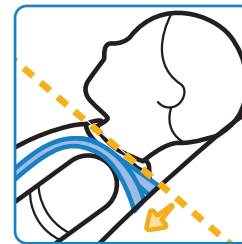

Harness Strap Position

The harness strap **must be at or slightly below** the shoulders; **never above.**

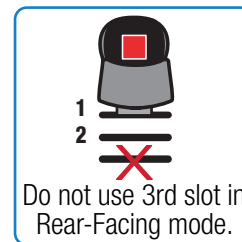

Buckle Position

Buckle must be used in either the **1st or 2nd slot**. Choose the slot closest to your child.

The buckle **should not be underneath or behind** your child.

Need to make adjustments?

To change headrest/harness height, see page 12.

To change buckle position, see pages 13-15.

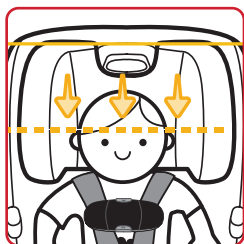

Head Position

The tops of your child's ears **must be below** the top of the car seat's headrest.

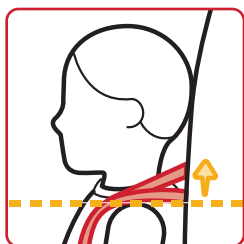

Harness Strap Position

The harness strap **must be at or slightly above** the shoulders; **never below**.

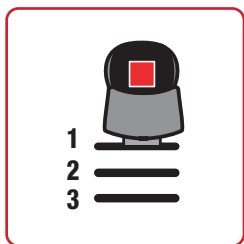

Buckle Position

Buckle can be used in **any slot**. Choose the slot closest to your child.

The buckle **should not be underneath or behind** your child.

Need to make adjustments?

To change headrest/harness height, see page 12.

To change buckle position, see pages 13-15.

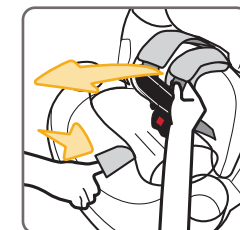
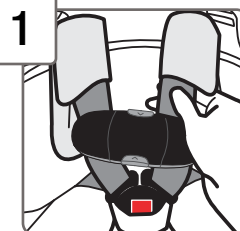

1 Fully Loosen Harness Straps

Place your hand between the harness cover and harness strap.

You may need to undo the harness cover or move the chest clip down.

Push down on harness release lever (through opening in pad) while pulling out on harness straps as shown.

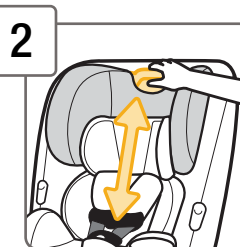

2 Changing Headrest/ Harness Height

Squeeze the button on the headrest/harness adjustment handle.

Move the headrest up or down to the proper height for your child.

Make sure it is locked securely.

For **Rear-Facing** child fit, see page 10.

For **Forward-Facing** child fit, see page 11.

Check your child's fit often.

If you cannot achieve a snug harness fit for your child, see page 16.

To learn how to check harness tightness, see pages 47-49.

Check the harness straps often for any wear or damage.

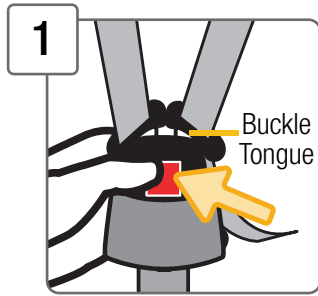

1 Unbuckle Harness

Press in on red button and pull out buckle tongues.

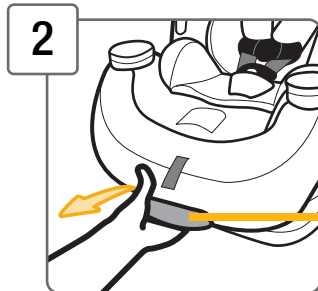

2 Fully Recline the Car Seat

Pull out on recline handle and push top of child restraint back. The recline handle is at the front of the car seat and under the pad.

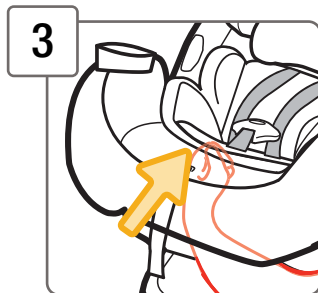

3 Locate the Buckle's Metal Retainer

Reach under the seat between the base and shell and through the recline handle.

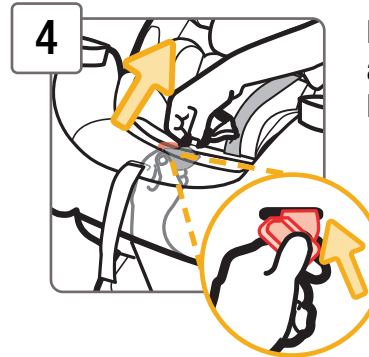

4 Rotate Metal Retainer and Push It Up Through Buckle Slot in Shell

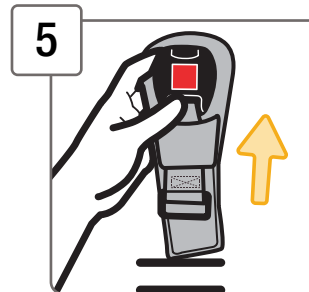

5 From Top of Seat, Pull Buckle and Buckle Cover Out of Shell and Pad

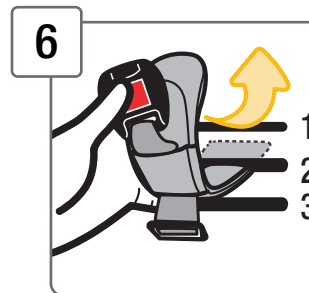

6 Slide Buckle Cover into Seat Pad Slot Closest to Child

Buckle **must** face out.

Rear-Facing Mode:
You **must** use the 1st or 2nd buckle slots.

Forward-Facing Mode:
Any slot can be used.

Buckle cover only goes through slot in pad. It lays flat underneath the pad as shown.

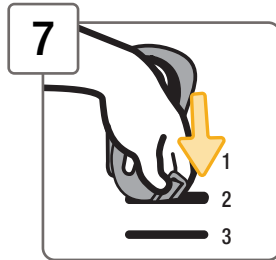

7 Insert Buckle's Metal Retainer into Same Slot As Buckle Cover

Buckle **must** face out.

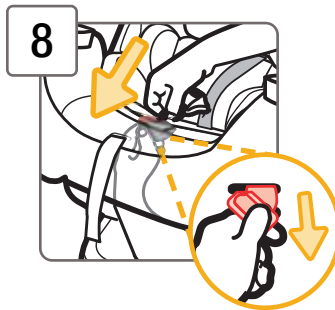

8 Reach Under the Seat Between Base and Shell and Through Recline Handle

Pull buckle's metal retainer completely through pad and shell.

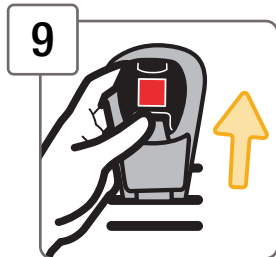

9 Check Buckle

Pull up on buckle to make sure it is secured.

The buckle **must not** pull out.

Check your child's fit often.

If you cannot achieve a snug harness fit for your child, see page 16.

To learn how to check harness tightness, see pages 47-49.

⚠ Failure to place buckle's metal retainer completely through pad and shell can result in serious injury or death.

Buckle Adjustment for Smaller Infants

If you cannot achieve a snug harness fit for your child, you may need to adjust the buckle strap length as shown in this section.

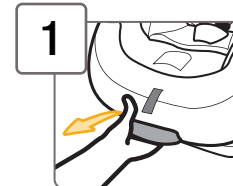

1 With Buckle in the 1st Slot, Fully Recline the Car Seat

If you need to move the buckle to the 1st slot, see pages 13-15.

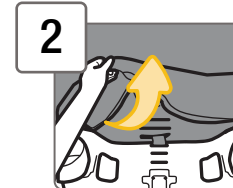

2 Pull Up Front of Car Seat Pad



3 From Bottom of Seat, Pull Metal Retainer Down and Push It Up into Middle Slot As Shown

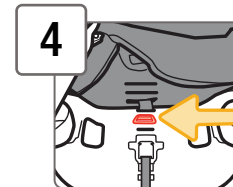

4 From Top of Seat, Lay the Metal Retainer Flat Against the Shell As Shown

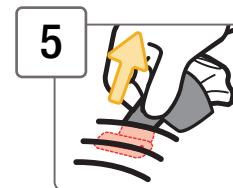

5 Tuck Car Seat Pad Back Around Front of Car Seat and Check Buckle

Pull up on buckle to make sure it is secured. The buckle **must not** pull out.

Check your child's fit often. To learn how to check harness tightness, see pages 47-49.

This car seat has 3 positions.

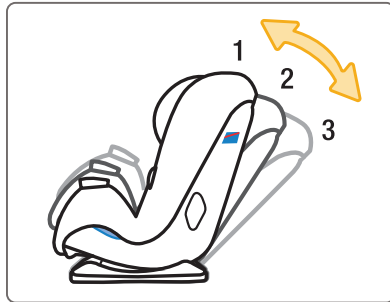

Rear-Facing Mode - 3 Reclined or 2 Semi-reclined

For children who cannot sit up unassisted, the level line on shell **must** be parallel with the ground using either Position 3 or 2.

For children who can sit up unassisted, you may rotate the child restraint to be more upright in Position 2.

Forward-Facing Mode - 1 Upright or 2 Semi-reclined*

Booster Seat Mode - 1 Upright or 2 Semi-reclined*

*When used in **Forward-Facing** or **Booster Seat** mode, the semi-reclined position is to be used only if necessary to install the child restraint or booster seat flush against the vehicle seat back. Vehicle seat back must be upright.



To Recline: Pull out on recline handle and push top of child restraint back.

For More Upright: Pull out on recline handle and pull top of child restraint forward.

The recline handle is at the front of the car seat and under the pad.



For Use in Rear-Facing or Forward-Facing Mode

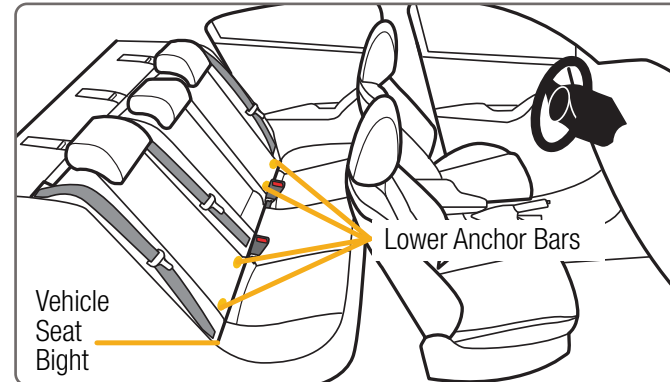

Your vehicle's features may be considerably different than those pictured here.

The lower anchors of LATCH (Lower Anchors and Tethers for CHildren) is a universal system for installing child restraints without using vehicle seat belts.

The lower anchor can **ONLY** be used in vehicles that have the lower anchor bars installed in designated seating positions. Most vehicles manufactured after September 2002 are equipped with lower anchor bars.

Check your vehicle owner's manual to see which seating positions may be equipped with LATCH: lower anchor bars.



Do not use both the lower anchor belt and vehicle belt at the same time.

When used correctly the lower anchor belt or vehicle belts are equally safe.

continued on next page

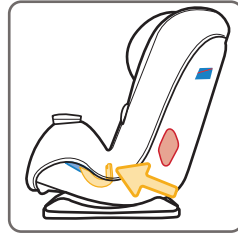

**Lower Anchor Belt
Storage Location**

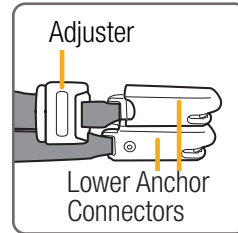

**Lower Anchor
Belt Parts**

To Remove Lower Anchor Belt from Storage

Location on Car Seat: Press the red release button on each connector, then pull the connectors off of storage attachments.

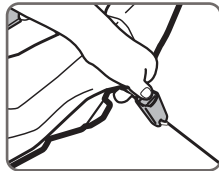

To Remove Lower Anchor Belt from Vehicle Lower Anchor Bars:

Press the red release button on each connector, then pull the connectors out of the vehicle seat bight.

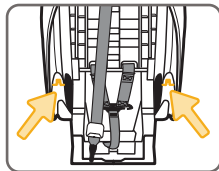

**Lower Anchor Belt
Storage Location**

To Store Lower Anchor Belt:

When using vehicle belts, using the **Booster Seat mode**, or when the car seat is not installed in a vehicle, the lower anchor belt must be properly stored in its storage location.

Thread lower anchor belt through rear-facing belt path then attach connectors to storage attachments as shown.

Gently tighten to remove slack.

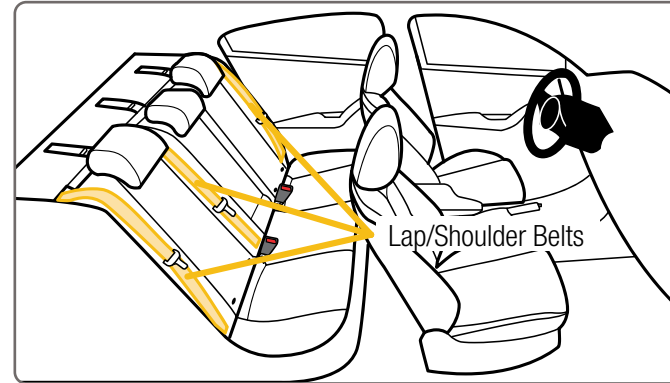

Your vehicle's features may be considerably different than those pictured here.

If lower anchors are not an option or if your child weighs more than **40 lb (18 kg)**, you must use the vehicle seat belt system to install the child restraint.

Not all vehicle belts and seating positions will work with child restraints.

Please go through the steps following steps to understand how to lock a child restraint in **Rear-Facing** or **Forward-Facing** mode with a vehicle belt.



1



You **MUST** Review Your Vehicle Owner's Manual

Your vehicle owner's manual will let you know which vehicle belts and seating positions child restraints can be installed in.

2



Determine How the Child Restraint Will Be Locked Into Place

The vehicle belt **must not** loosen after tightening. This means there needs to be a way to lock the vehicle belt.

The ways this can be done are:

- By using the seat belt's retractor (see step 3); **OR**
- By using the seat belt's latch plate (see step 4).

3

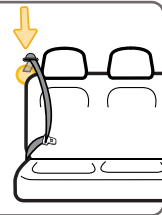

Check the Retractor

Retractors pull seat belts into stored positions and lock the belt to hold passengers in place.

See the next page for some common types of vehicle belt retractors that will work with this child restraint.



Types of Retractors

Switchable Retractor (most vehicles have this type)



This retractor can be switched to a locking mode.

You **must have the retractor in the locking mode** to use the seat belt with this child restraint.

Switching to locking mode: Slowly pull the shoulder belt all the way out, then let it go back in an inch or two.

As it goes back in, you will most likely hear a ratcheting sound.

Gently pull the belt to see if it has locked. You will not be able to pull any more belt out if the lock has engaged.

Automatic Locking Retractor



This retractor always locks.

It will automatically lock after slowly pulling the seat belt out at least halfway and letting the belt go back into the retractor an inch or two.

Emergency Locking Retractor

See Step 4, "Check Latch Plates".

If the retractor does not lock, it is most likely an Emergency Locking Retractor. These retractors only lock during a sudden stop or collision.

You will need to determine if your seat belt's latch plate can lock the belt. See Step 4, "Check Latch Plates".

continued on next page



4

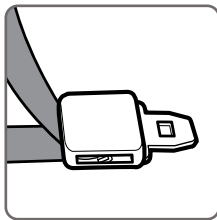

Locking Latch Plate

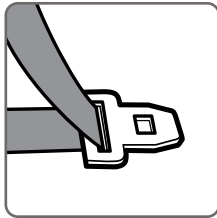

Emergency Locking Retractor with a Sliding Latch Plate

Check Latch Plates

Latch plates are the part of the seat belt that goes into the buckle.

To see if the latch plate locks:

Buckle the vehicle belt.

Then firmly tug the lap portion of the seat belt while pulling it up.

If the vehicle belt does not slide through the latch plate, it's locked.

If the latch plate slides up and down the vehicle belt, it is a **sliding latch plate**.

Sliding latch plates easily slip between the lap and shoulder portions of the belt.

If you have an Emergency Locking Retractor with a Sliding Latch Plate, you must use a locking clip.

Please contact us for one.

See page 77.

Never Use With This Child Restraint

Emergency Locking Retractor Lap Only Belt



Inflatable Seat Belts



For Forward-Facing Mode Only

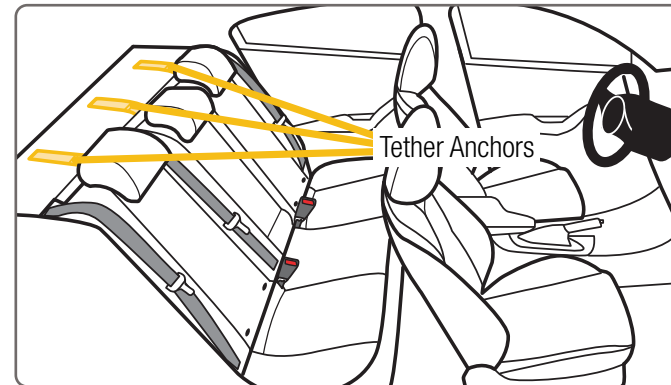

Your vehicle's features may be considerably different than those pictured here.

You **must always attach, adjust, and secure the top anchorage (tether) strap** when installing the child restraint forward-facing with internal harness. Tethers improve the installation and stability of child restraints and reduce the risk of injury.

Attach the tether hook to the tether anchor designated by your vehicle manufacturer for that seating position. Check your vehicle owner's manual for more information.

If the seating position does not have a tether anchor, use a different seating position or see your dealer or a qualified mechanic and have one installed.



Using this child restraint without the tether strap anchored as required by the manufacturer would be a misuse of the child restraint and, in a sudden stop or crash, could result in serious injury or death.

Do not fasten multiple tether hooks on the same tether anchor in the vehicle.

continued on next page

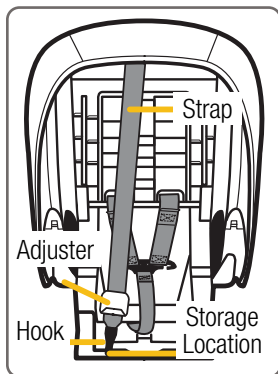

Tether Storage
and Parts

Storing Tether Strap

When installing Rear-Facing, using the Booster Seat mode, or when the car seat is not installed in a vehicle, attach the tether hook to its storage attachment on back of car seat as shown.

Gently tighten to remove slack.

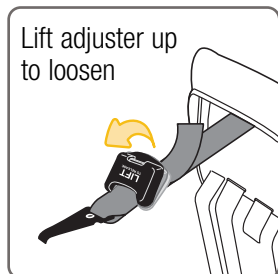
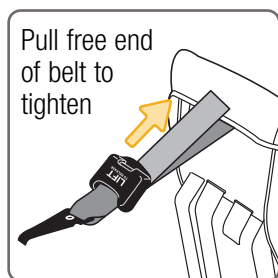

Adjusting Tether Strap

To tighten: After the child restraint is locked into place with the lower anchor belt or vehicle belt, push down on child restraint and gently pull on free end of tether strap.

To loosen: Lift up on tether adjuster and push it towards tether hook.



4-40 lb (1.8-18 kg) and
19-40 in. (48-101.6 cm)

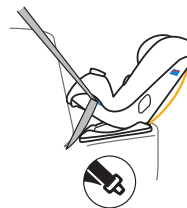

Lap/Shoulder
Belt

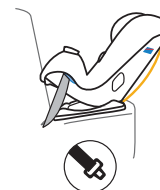

Lap Belt



LATCH: Lower
Anchor Belt



Never install a rear-facing child restraint in the front seat of a vehicle equipped with an active frontal airbag.

Do not use the tether for rear-facing mode. Secure tether strap to its storage location.

Do not use the lower anchor belt along with the vehicle lap or lap/shoulder belt.

Do not fasten multiple lower anchor connectors on the same lower anchor bar in the vehicle.

Check the vehicle belt or the lower anchor belt before each use.

Use only if the belt can be tightened properly and locked securely in place.

This child restraint **MUST** always face the rear of the vehicle until the child is at least 1 year old and weighs 22 lb (10 kg).

Failure to follow these warnings can result in serious injury or death.



Before you begin installing the seat into your vehicle, did you check:



Your child's weight and height?

See page 7.



Your child's fit? See page 10.

Do you need to make adjustments to the harness/headrest height or the buckle position?

1

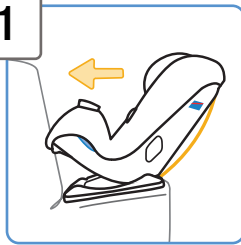

Place Car Seat Rear-Facing in Back Seat

2

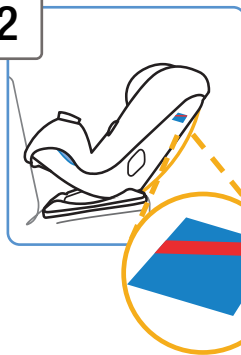

Check Rear-Facing Level Line

For children who cannot sit up unassisted, the level line **must** be parallel with the ground.

Recline the car seat to achieve the proper angle, see step 3.

For children who can sit up unassisted, you may rotate the child restraint to be more upright in Position 2.



3

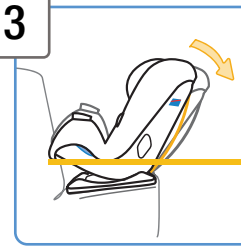

Recline the Car Seat

Pull out on recline handle and push top of child restraint back.

The recline handle is at the front of the car seat and under the pad.

4

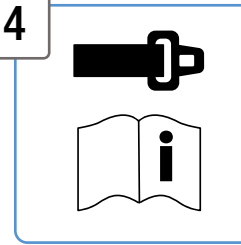

Check if Your Vehicle Belts Will Work With This Child Restraint

This is very important because **not all vehicle belts will work with child restraints.**

Review pages 20-23 and your vehicle owner's manual to determine what kind of vehicle belt you have and how to lock a child restraint in place.

5

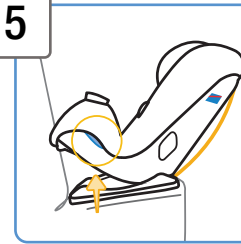

Locate Rear-Facing Belt Path

continued on next page



6

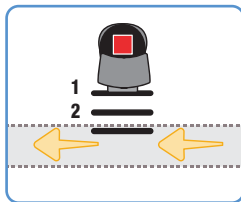
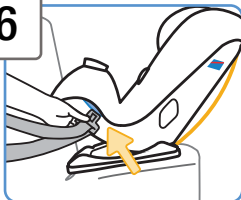

Route the Vehicle Belt

Thread the vehicle belt into the **Rear-Facing Belt Path** opening.

Pull it across the seat, under the seat pad, in front of the buckle, and out through the other **Rear-Facing Belt Path** opening.

Do not twist belt.

7

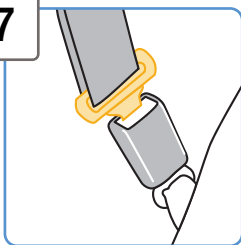

Buckle the Vehicle Belt

8

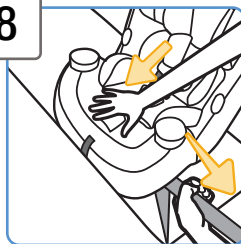

Tighten Belt

Place hand in child restraint.

Firmly push child restraint down and back towards the vehicle seat back while pulling the shoulder belt or the free end of lap belt parallel with the belt path through the belt path opening as shown.



9

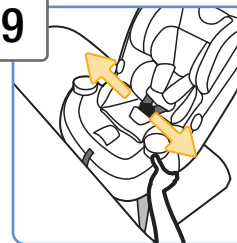

Check Belt Tightness

Hold child restraint at the belt path with your weaker hand.

Push and pull from side to side.

It should not move more than **1 in. (2.5 cm)**.

If it moves more than 1 in. (2.5 cm), you can try:

- A. Pulling the belt tighter.
- B. Reinstalling the child restraint.
- C. Changing to a different seating location.
- D. Switching to lower anchor belt installation if lower anchors are available in your vehicle.

10



Secure Child in Car Seat

To properly secure your child in the car seat, see pages 47-49.

Check your child's fit often and make any needed adjustments to the car seat as they grow.

continued on next page



11

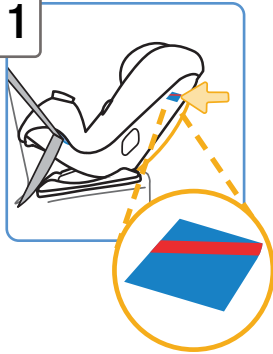

Recheck Rear-Facing Level Line

Redo the installation if the car seat is not reclined correctly for your child.



NOTE: You may need to place a tightly rolled towel(s) or foam pool noodle(s) under the front of the base to help achieve the correct recline.

Check often to be sure padding is still in place and the belt is tight.



Finished!

Check the tightness of the install often to make sure it has not loosened.

Rear-Facing LATCH: Lower Anchor Install



Before you begin installing the seat into your vehicle, did you check:

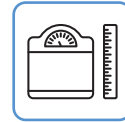

Your child's weight and height?
See page 7.



Your child's fit? See page 10.
Do you need to make adjustments to the harness/headrest height or the buckle position?

1

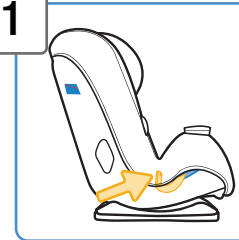

Remove Lower Anchor Belt from Storage Location

Or if the lower anchor belt was used Forward-Facing, remove it from the Forward-Facing belt path so both connectors are on the same side of the seat.

2

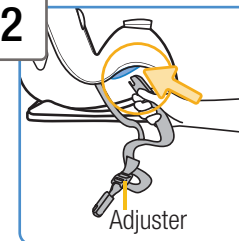

Locate Rear-Facing Belt Path

Thread the connector without the adjuster closest to it through the **Rear-Facing Belt Path** opening as shown.

continued on next page

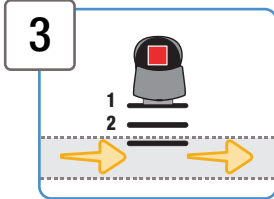

3 Pull Lower Anchor Belt Across the Seat

It must be under the seat pad, in front of the buckle, and go out through the other **Rear-Facing Belt Path** opening. Do not twist belt.

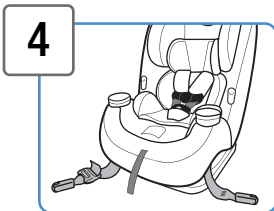

4 Finished Lower Anchor Belt Routing

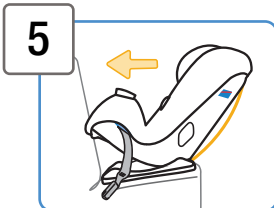

5 Place Car Seat Rear-Facing in Back Seat

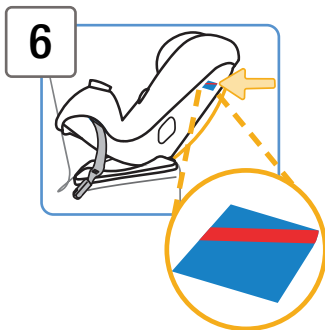

6 Check Rear-Facing Level Line

For children who cannot sit up unassisted, the level line **must** be parallel with the ground.

Recline the car seat to achieve the proper angle, see step 7.

For children who can sit up unassisted, you may rotate the child restraint to be more upright in Position 2.

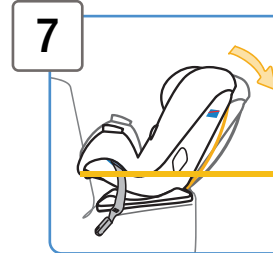

7 Recline the Car Seat

Pull out on recline handle and push top of child restraint back.

The recline handle is at the front of the car seat and under the pad.

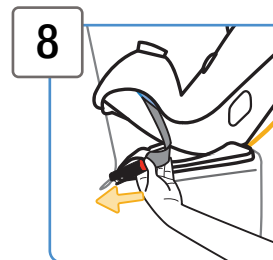

8 Attach Lower Anchor Connectors to Vehicle's Lower Anchors

Review your vehicle owner's manual for lower anchor locations and lower anchor belt use.

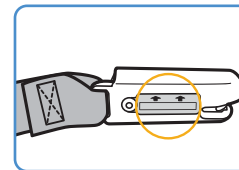

Make sure arrows on connectors are facing up.

Fasten one lower anchor belt connector to the anchor located in the vehicle seat bight.



Repeat for other side of child restraint.



9

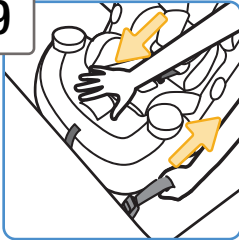

Tighten Belt

Place hand in child restraint.
Firmly push child restraint down and towards the vehicle seat back while pulling the free end of the belt to tighten.

It may be easier to tighten the belt by reaching into the **Rear-Facing Belt Path** and pulling the free end of the belt towards you and parallel with the belt path as shown.

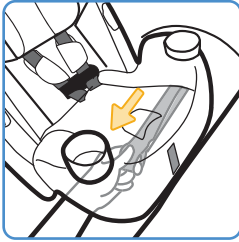

10

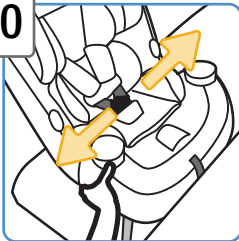

Check Belt Tightness

Hold child restraint at the belt path with your weaker hand.
Push and pull from side to side.
It should not move more than **1 in. (2.5 cm)**.

If it moves more than 1 in. (2.5 cm), you can try:

- A. Pulling the belt tighter.
- B. Reinstalling the child restraint.
- C. Changing to a different seating location.
- D. Switching to vehicle belt installation.



11

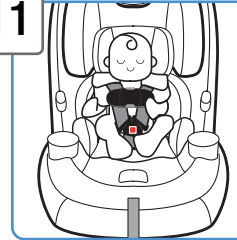

Secure Child in Car Seat

To properly secure your child in the car seat, see pages 47-49.

Check your child's fit often and make any needed adjustments to the car seat as they grow.

12

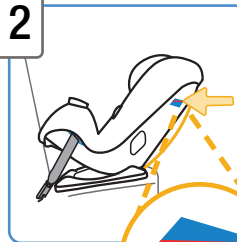

Recheck Rear-Facing Level Line

Redo the installation if the car seat is not reclined correctly for your child.

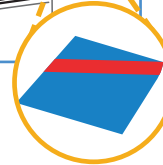

NOTE: You may need to place a tightly rolled towel(s) or foam pool noodle(s) under the front of the base to help achieve the correct recline.

Check often to be sure padding is still in place and the belt is tight.

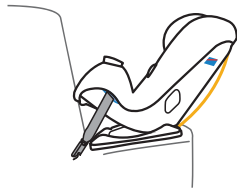
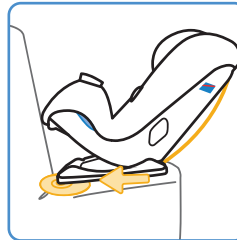

Finished!

Check the tightness of the install often to make sure it has not loosened.



Forward-Facing Mode

**22-65 lb (10.1-29 kg) and
29-49 in. (73.6-125 cm)
and at least 1 year old**



**Lap/Shoulder
Belt and Tether**

Up to 65 lb
(29 kg)



**Lap Belt
and Tether**

Up to 65 lb
(29 kg)



**LATCH: Lower Anchor
Belt and Tether**

Do not install by this
method for a child
weighing more than
40 lbs (18 kg).



Do not use the lower anchors of the child restraint anchorage system (LATCH system) to attach this child restraint when restraining a child weighing more than 40 lbs (18 kg).

The vehicle belt must be used for installation if your child weighs more than 40 lb (18 kg).

Do not use the lower anchor belt along with the vehicle lap or lap/shoulder belt.

Check the vehicle belt or the lower anchor belt before each use. Use only if the belt can be tightened properly and locked securely in place.

Do not fasten multiple lower anchor connectors on the same lower anchor bar in the vehicle.

In this child restraint your child **MUST** be at least 1 year old and weigh 22 lb (10 kg) before they sit forward-facing.

Failure to follow these warnings can result in serious injury or death.

Forward-Facing Vehicle Belt + Tether Install



Before you begin installing the seat into your vehicle, did you check:

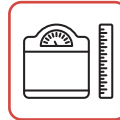

Your child's weight and height?

See page 37.



Your child's fit? See page 11.

Do you need to make adjustments to the harness/headrest height or the buckle position?

1

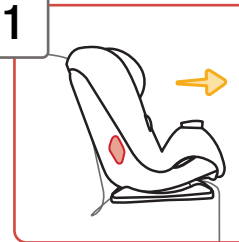

Place Car Seat Forward-Facing in Back Seat

2

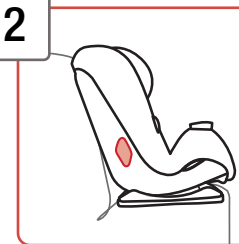

Make Car Seat Flush Against Vehicle Seat

Put the child restraint into Position 1.

Only use the semi-reclined position if necessary to install the child restraint flush against the vehicle seat back.

Vehicle seat back must be upright.

continued on next page

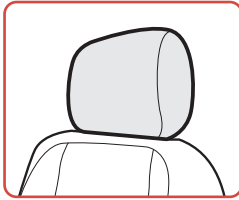

NOTE: If your vehicle seat has a headrest that interferes with achieving a flush car seat fit, check your vehicle owner's manual to see if it can be removed, adjusted, or if there are other possible seating locations.

3

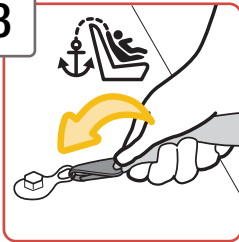

Loosely Attach Tether Hook to Vehicle's Tether Anchor

Check vehicle owner's manual for specific location.

4

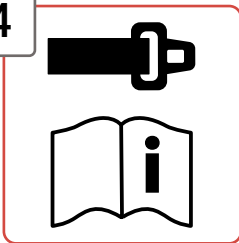

Check if Your Vehicle Belts Will Work With This Child Restraint

This is very important because **not all vehicle belts will work with child restraints.**

Review pages 20-23 and your vehicle owner's manual to determine what kind of vehicle belt you have and how to lock a child restraint in place.

5

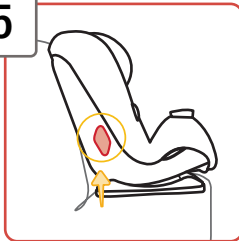

Locate Forward-Facing Belt Path



6

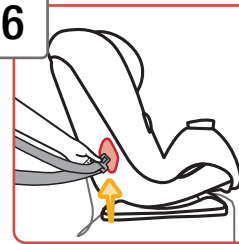

Route the Vehicle Belt

Thread the vehicle belt through **Forward-Facing Belt Path** opening.

Pull it across the seat. Then thread it through the other **Forward-Facing Belt Path** opening. **Do not twist belt.**

7

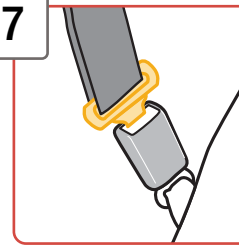

Buckle the Vehicle Belt

8

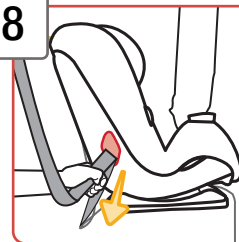

Tighten Belt

Place hand in child restraint.

Firmly push child restraint down while pulling the shoulder belt or free end of the lap belt parallel with the belt path through the belt path opening as shown.

9

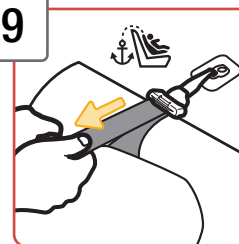

Tighten Tether

Push firmly on the back of the seat and pull the tether strap to remove all slack and create tension on the strap.

continued on next page



10

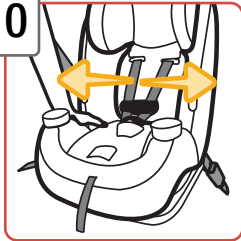

Check Belt Tightness

Hold child restraint at the belt path with your weaker hand. Push and pull from side to side. It should not move more than **1 in. (2.5 cm)**.

If it moves more than 1 in. (2.5 cm), you can try:

- A. Putting your knee in the seat and pulling the belt tighter.
- B. Reinstalling the child restraint.
- C. Changing to a different seating location.
- D. Switching to the lower anchor belt installation if lower anchors are available in your vehicle.



Finished!

Check the tightness of the install often to make sure it has not loosened.



Securing Child in Car Seat

To properly secure your child in the car seat, see pages 47-49. Check your child's fit often and make any needed adjustments to the car seat as they grow.

Forward-Facing LATCH: Lower Anchor + Tether Install



Do not use the lower anchors of the child restraint anchorage system (LATCH system) to attach this child restraint when restraining a child weighing more than 40 lbs (18 kg).

Before you begin installing the seat into your vehicle, did you check:

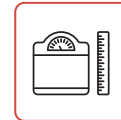

Your child's weight and height?
See page 37.



Your child's fit? See page 11.
Do you need to make adjustments to the harness/headrest height or the buckle position?

1

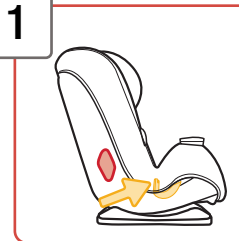

Remove Lower Anchor Belt from Storage Location

Remove it from the rear-facing belt path so both connectors are on the same side of the seat.

continued on next page



2

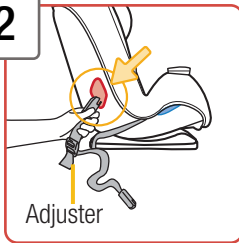

Locate Forward-Facing Belt Path

Thread the connector with the adjuster closest to it through the **Forward-Facing Belt Path** opening as shown.

Pull it across the seat. Then thread it through the other **Forward-Facing Belt Path** opening.

Do not twist belt.

3

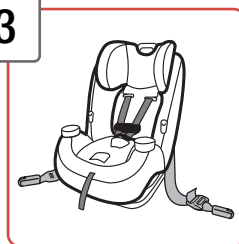

Finished Lower Anchor Belt Routing

4

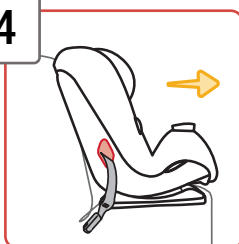

Place Car Seat Forward-Facing in Back Seat

5



Make Car Seat Flush Against Vehicle Seat

Put the child restraint into Position 1.

Only use the semi-reclined position if necessary to install the child restraint flush against the vehicle seat back.

Vehicle seat back must be upright.

NOTE: If your vehicle seat has a headrest that interferes with achieving a flush car seat fit, check your vehicle owner's manual to see if it can be removed, adjusted, or if there are other possible seating locations.

6

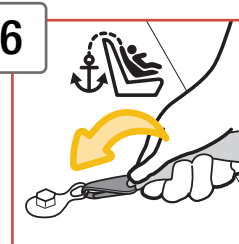

Loosely Attach Tether Hook to Vehicle's Tether Anchor

Check vehicle owner's manual for specific location.



7

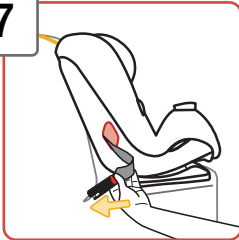

Attach Lower Anchor Connectors to Vehicle's Lower Anchors

Review your vehicle owner's manual for lower anchor locations and lower anchor belt use.

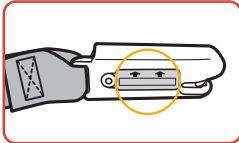

Make sure arrows on connectors are facing up.

Fasten one lower anchor belt connector to the anchor located in the vehicle seat bight.



Repeat for other side of child restraint.

8

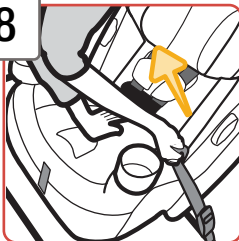

Tighten Belt

Place hand in child restraint.

Firmly push child restraint down while pulling the free end of the belt parallel with the belt path through the belt path opening as shown.

9

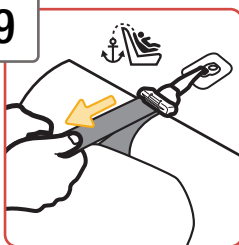

Tighten Tether

Push firmly on the back of the seat and pull the tether strap to remove all slack and create tension on the strap.



10



Check Belt Tightness

Hold child restraint at the belt path with your weaker hand.

Push and pull from side to side.

It should not move more than **1 in. (2.5 cm)**.

If it moves more than 1 in. (2.5 cm), you can try:

- Putting your knee in the seat and pulling the belt tighter.
- Reinstalling the child restraint.
- Changing to a different seating location.
- Switching to vehicle belt installation.

Finished!

Check the tightness of the install often to make sure it has not loosened.



Securing Child in Car Seat

To properly secure your child in the car seat, see pages 47-49.

Check your child's fit often and make any needed adjustments to the car seat as they grow.

1

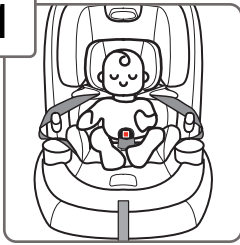
**Place Child in Car Seat**

The child's bottom and back should be flat against the car seat.

Position harness straps over your child's shoulders and upper thighs.

2

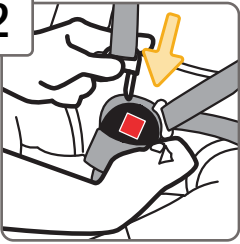
**Buckle Harness**

Push buckle tongues into buckle until you hear them "click".

Pull up on harness straps to make sure buckle is locked.

3

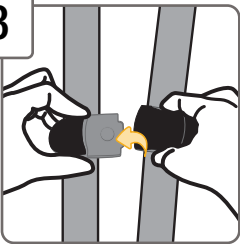
**Close Chest Clip**

Lay the right (top) half of the chest clip over the left (bottom) half and it will automatically snap together and lock.

Pull gently on each half of the chest clip together to make sure it is locked.

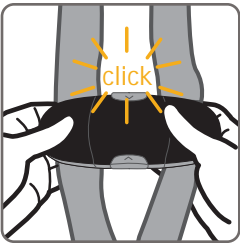

4

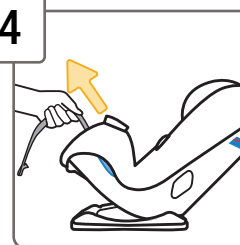
**Tighten Harness**

Pull harness adjustment strap straight out to snugly tighten harness.

5

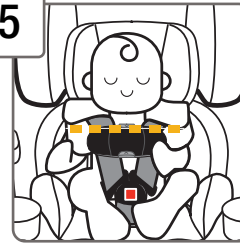
**Position Chest Clip**

Slide chest clip up the harness straps and position it at mid-chest (even with armpits) and away from the child's neck.

6

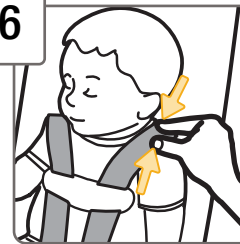
**Check Harness Tightness**

Unfasten harness covers.

Try to pinch the harness at the shoulders vertically between index finger and thumb as shown.

If your fingers slip off, the harness is tight enough.

If you can pinch the harness strap, tighten more.

Fasten harness covers.

A snug strap should not allow any slack. It lies in a relatively straight line without sagging. It does not press on the child's flesh or push the child's body into an unnatural position.



Finished!

The child is now secured in the car seat.

Check your child's fit often and make any needed adjustments to the car seat as they grow.

To Remove Child from Car Seat:

1. Loosen Harness Strap
2. Unbuckle Harness
3. Release Chest Clip
4. Remove Child



Failure to fasten and tighten the harness system correctly may allow the child to be ejected from the child restraint in a crash or sudden stop causing serious injury or death.



Do not mistake comfort for safety. Harness system must be snugly adjusted.

Do not put snowsuits or bulky garments on your child when placing them in the child restraint. Bulky clothing can prevent the harness straps from being tightened properly.



**40-100 lb (18.1-45.4 kg) and
43-52 in. (110.1-132.1 cm)**



Lap/Shoulder
Belt



Keep booster seat
belted when not
in use.



Do not use the harness system when using as a booster seat.

Use only the vehicle's lap and shoulder belt system when restraining the child in this booster seat. Do not use only the lap belt when using this seat as a booster seat.

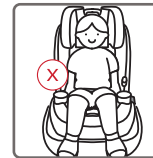

The shoulder belt must always be adjusted snugly across the child's chest. NEVER place shoulder belt under the child's arms or behind their back.

Do not use this booster seat if the tops of your child's ears are above the top of the booster seat's headrest.

Do not use LATCH when using as a booster seat. Secure lower anchor belt and tether strap to their storage locations.

Failure to follow these warnings can result in serious injury or death.

You must store the harness system and remove accessories (except the cup holders) when using the **Booster Seat** mode. To remove accessories, see pages 3-5.

Removing Buckle

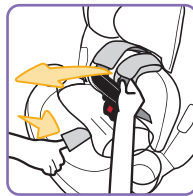
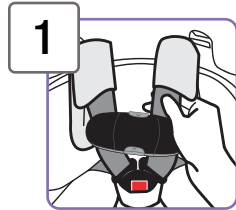

**Fully Loosen
Harness Straps**

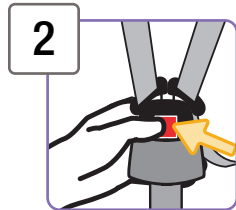

Unbuckle Harness

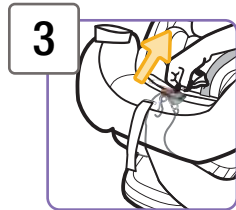

Locate Buckle's Metal Retainer

Fully recline the child restraint and reach under the seat between the base and shell and through the recline handle.

Rotate metal retainer and push it up through shell and pad.

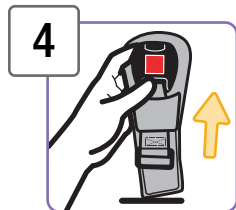

From Top of Seat, Pull Buckle and Buckle Cover Out of Shell and Pad
Store the buckle and buckle cover in a safe place for future use.

Storing Harness System

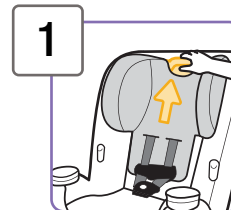

**Adjust Headrest to
Highest Position**

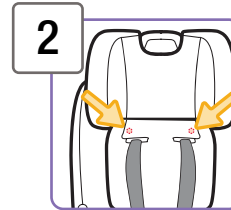

Undo Fasteners on Headrest Pad

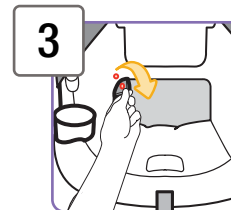

**Undo Fasteners on Seat Pad As
Shown**

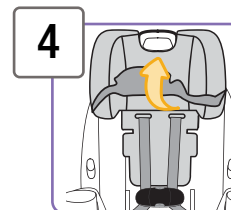

**Pull Headrest Pad Off Bottom of
Headrest As Shown**

continued on next page

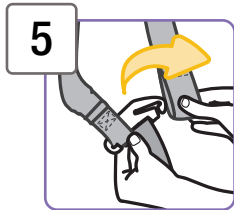

5 From Back of Seat, Remove Harness Strap Loops From Splitter Plate

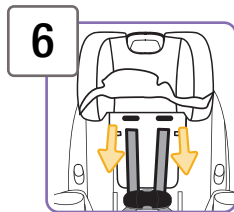

6 Pull Harness Straps Out of Shoulder Harness Slots and Unthread Chest Clip

Store the chest clip in a safe place for future use.

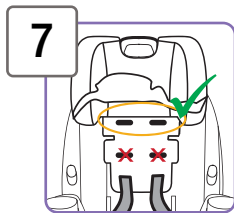
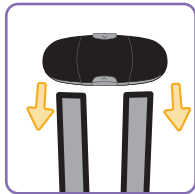

7 Rethread Harness Straps into the Top Shoulder Harness Slots

Do not use the lower shoulder harness slots.

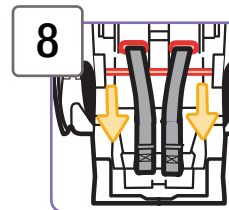
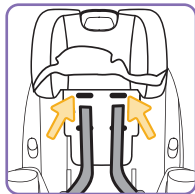

8 From Back of Seat, Thread Harness Straps Over Metal Bar

Do not twist harness straps.

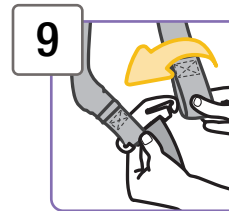

9 Attach Harness Strap Loops to Splitter Plate As Shown

Sewn ends of the harness strap loops **must** face towards you. Do not twist harness strap or harness adjustment strap.

Make sure the harness strap loops are fitted **completely on** both sides of the splitter plate.

Check your child's fit often.

If you cannot achieve a snug harness fit for your child, see page 16.

To learn how to check harness tightness, see pages 47-49. Check the harness straps often for any wear or damage.

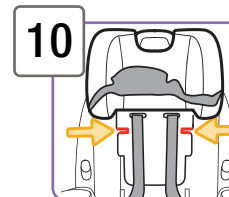
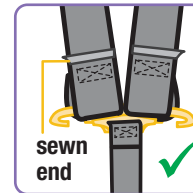

10 Thread Harness Straps into Slots on Sides of Headrest As Shown

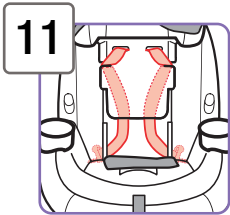

11

Place Harness Straps and Buckle Tongues Behind the Headrest and Seat Pad As Shown

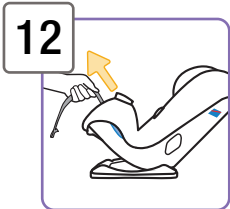

12

Tighten Harness

Pull harness adjustment strap straight out to remove any slack from the harness system.

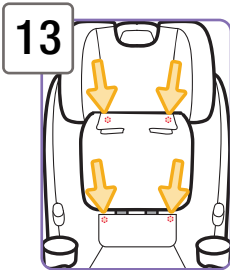

13

Pull Headrest Pad Down and Wrap Around Bottom of Headrest

Attach fasteners on headrest and seat pad.

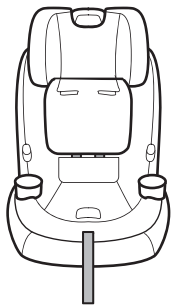

Finished!

The car seat has been converted to **Booster Seat Mode**.

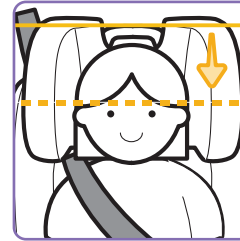

Head Position

Tops of the child's ears should never be above the top of the headrest.



Shoulder Belt Position

The shoulder belt should lay snugly across the center of the child's shoulder and across the chest and not on their face or neck.

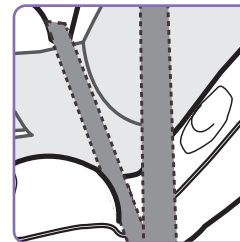

Lap Belt Position

The lap belt should lay snugly across the child's hips and not on their stomach.



You must store the harness system when using the **Booster Seat** mode. See pages 51-55.

1

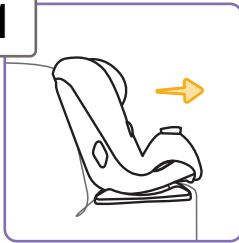

Place Booster Seat Forward-Facing in Back Seat

Put the booster seat into Position 1. Only use the semi-reclined position if necessary to install the child restraint flush against the vehicle seat back.

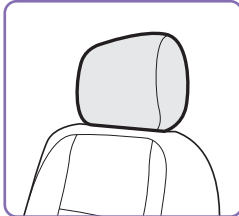

Vehicle seat back must be upright.

NOTE: If your vehicle seat has a headrest that interferes with achieving a flush car seat fit, check your vehicle owner's manual to see if it can be removed, adjusted, or if there are other possible seating locations.

2



Have Child Sit in Booster Seat

3

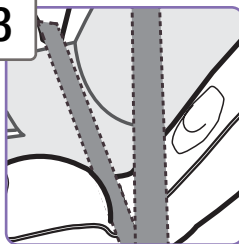

Position Lap Belt on Child

Route the lap belt portion of vehicle belt through the booster belt path as shown.

The lap belt should lay snugly across the child's upper thighs and not on the stomach.



4

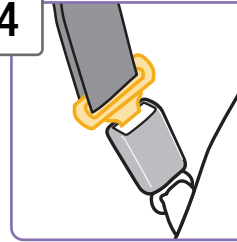

Buckle the Vehicle Belt

Pull up on lap belt to tighten.

5



Position Shoulder Belt on Child

Pull up on shoulder belt to tighten.

For models with EZ Out Harness Holders: The shoulder belt should lay under the EZ Out Harness Holder as shown.

For models without EZ Out Harness Holders: The shoulder belt will fall naturally into place.

The shoulder belt should lay snugly across the center of the child's shoulder and across the chest and not on their face or neck.

Only use the shoulder belt-positioning guide in the headrest if necessary to help position the shoulder belt correctly on the child.



Finished!

Check periodically to make sure your child has not moved out of position and loosened the shoulder belt.

Removing Seat Pad Set For Cleaning

You do not need to remove the harness system to remove the pad from the shell.

To remove accessories, see pages 3-5.

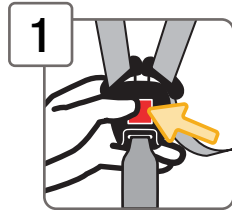

1

Unbuckle Harness

Press in on red button and pull out buckle tongues.

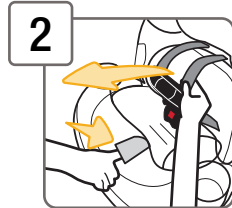

2

Fully Loosen Harness Straps

Push down on harness release lever (through opening in pad) while pulling out on harness straps as shown.

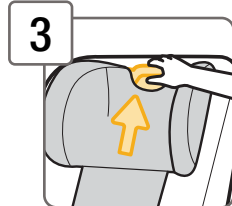

3

Adjust Headrest to Highest Position

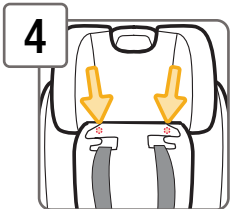

4

Undo Fasteners on Headrest Pad As Shown

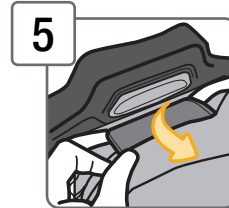

5

At the Headrest/Harness Adjustment Handle, Pull the Fabric Tab Out from Between the Headrest and Headrest Foam As Shown

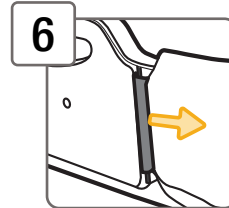

6

At the Back of the Headrest, Pull the Fabric Tabs Out from Slots in Headrest As Shown

Repeat for other side.

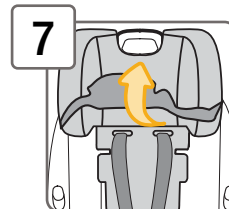

7

Gently Pull Headrest Pad Off Bottom of Headrest As Shown

Remove headrest pad from shell.

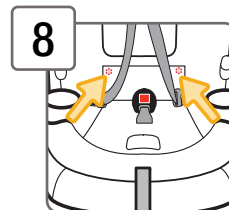

8

Undo Fasteners on Seat Pad As Shown

continued on next page

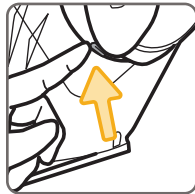
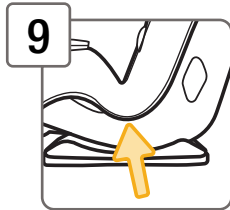

9 Locate Seat Pad Tabs on Sides of Seat

There is one on each side.

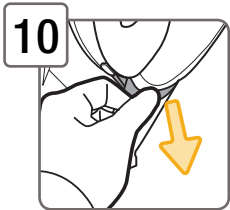

10 Pull Down Seat Pad to Stretch Elastic Strap

Release elastic strap from tab on each side of seat.

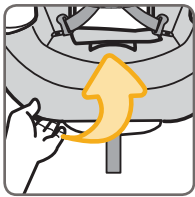
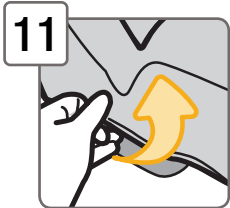

11 Pull Pad Off Sides and Front of Seat

Pull buckle strap and harness adjustment strap out of openings in seat pad.

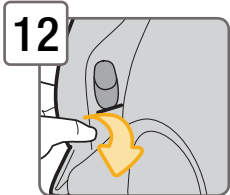

12 Pull Pad Down and Off of Bottom of EZ Out Harness Holders

(on select models)

Pull up to remove completely.

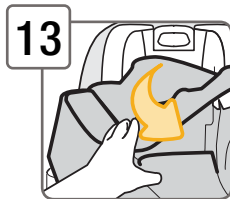

13 Lower Headrest to Middle of Seat and Pull Pad off Shell

Cleaning Parts of Car Seat and Installing Seat Pad Set

Cleaning Seat Pad, Buckle Cover, Harness Covers, Head & Back Pillows, and Infant Positioning Pillow

Machine wash separately with cold water on a gentle cycle. Make sure harness covers are closed so fastening strips are not exposed. Do not use bleach. Tumble dry separately for 10-12 minutes on low heat. Remove immediately.

Cleaning Harness Strap

Check the harness straps often for any wear or damage.

Spot clean using warm sudsy water and damp cloth.

Spilled food and liquids on the child restraint may result in mold or bacterial growth over time. These spills could also attract insects or rodents.

⚠ Do not fully pull the harness strap out of the car seat. Leave it threaded in the hip harness slots. If removed, you will not be able to rethread it.

Cleaning Buckle & Car Seat Shell

Spot clean using warm sudsy water and damp cloth. Do not submerge into water.

⚠ Do not use child restraint without the seat pad or with damaged harness straps. Failure to do this can result in serious injury or death.

Installing Seat Pad Set

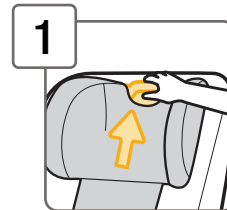

1 Adjust Headrest to Highest Position

continued on next page

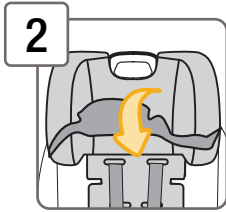

2 Gently Pull Headrest Pad onto Headrest

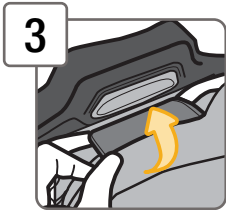

3 At the Headrest/Harness Adjustment Handle, Slide the Fabric Tab In Between the Headrest and Headrest Foam As Shown

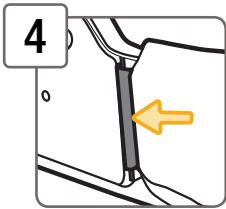

4 At the Back of the Headrest, Slide the Fabric Tabs Into the Slots in Headrest As Shown
Repeat for other side.

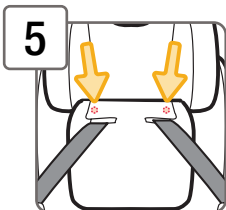

5 Slide Harness Straps Into Slots in Pad and Attach Fasteners
Pull headrest pad down around bottom of headrest.

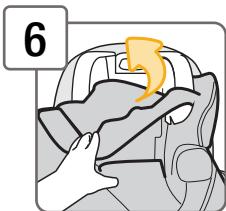

6 Lower Headrest to Middle of Seat
Starting from bottom of car seat, slip pad on shell.

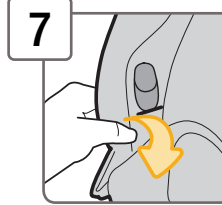

7 Push EZ Out Harness Holders Through Slots in Pad
(on select models)

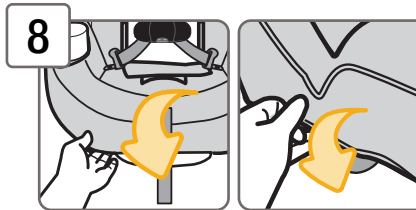

8 Wrap Pad Around Bottom and Sides of Shell

Pull harness adjustment strap and buckle through the slots in pad.



9 Locate Seat Pad Tabs on Sides of Seat

There is one on each side.



10 Attach Elastic Straps to Tabs on Sides of Seat

There is one on each side.

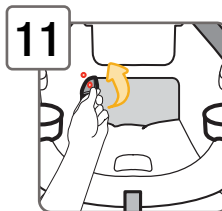

11 Attach Seat Pad Fasteners As Shown

Installing Buckle

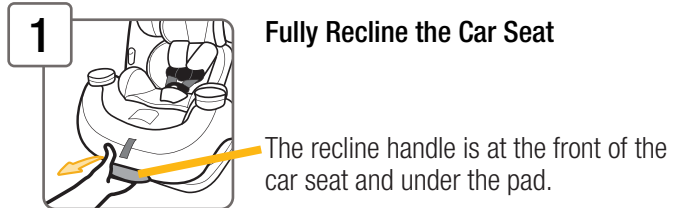

1 Fully Recline the Car Seat

The recline handle is at the front of the car seat and under the pad.

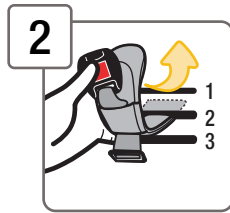

2 Slide Buckle Cover into Seat Pad Slot Closest to Child

Buckle **must** face out.

Rear-Facing Mode:

You must use the 1st or 2nd buckle slots.

Forward-Facing Mode: Any slot can be used.

Buckle cover only goes through slot in pad. It lays flat underneath the pad as shown.

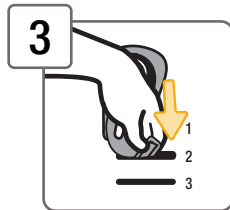

3 Insert Buckle's Metal Retainer into Same Slot As Buckle Cover

Buckle **must** face out.

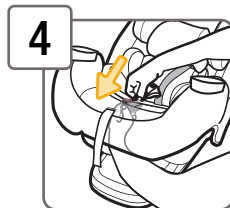

4 Reach Under Seat Between Base and Shell and Through Recline Handle

Pull metal retainer completely through pad and shell.

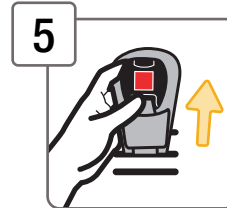

5 Check Buckle

Pull up on buckle to make sure it is secured.

The buckle **must** not pull out.

Installing Harness Straps and Chest Clip

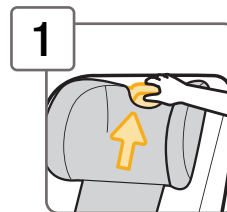

1 Adjust Headrest to Highest Position

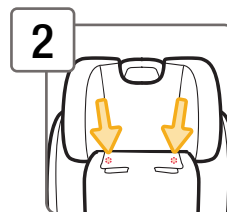

2 Undo Fasteners on Headrest Pad and Seat Pad

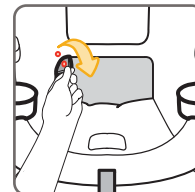

continued on next page

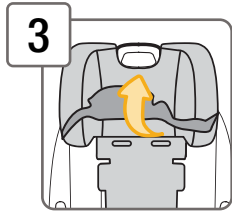

3 Gently Pull Headrest Pad Off Bottom of Headrest As Shown

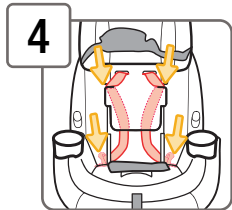

4 Loosen Harness Straps and Unthread Harness Straps From Slots on Side of Headrest

Pull harness straps and buckle tongues out from behind the headrest and seat pad.

Slide harness straps into slots in headrest pad.

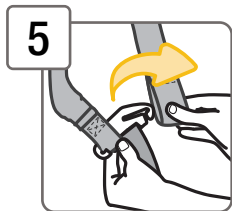

5 From Back of Seat, Remove Harness Strap Loops From Splitter Plate

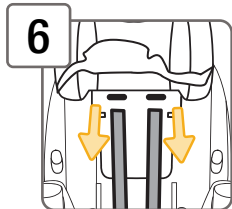

6 Pull Harness Straps Out of Shoulder Harness Slots

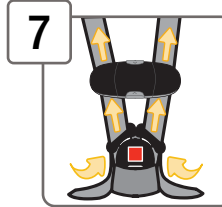

7 Thread Buckle and Chest Clip

If the buckle tongues have been unthreaded from the harness straps, insert them into the buckle.

Then thread harness strap ends through the back of the buckle tongues and through the chest clip as shown.

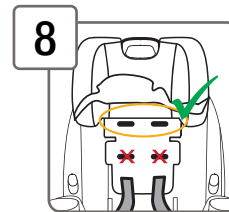

8 Rethread Harness Straps into the Top Shoulder Harness Slots

Do not use the lower shoulder harness slots.

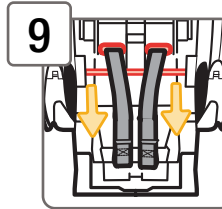
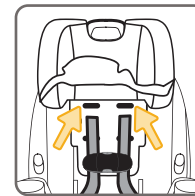

9 From Back of Seat, Thread Harness Straps Over Metal Bar

Do not twist harness straps.

continued on next page

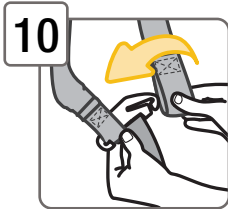

10

Attach Harness Strap Loops to Splitter Plate As Shown

Sewn ends of the harness strap loops **must** face towards you. **Do not** twist harness strap or harness adjustment strap.

Make sure the harness strap loops are fitted **completely** on both sides of the splitter plate.

Check your child's fit often.

If you cannot achieve a snug harness fit for your child, see page 16.

To learn how to check harness tightness, see pages 47-49.

Check the harness straps often for any wear or damage.

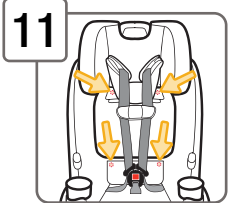
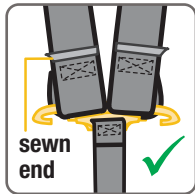

11

Attach Headrest and Seat Pad Fasteners

⚠️ Harness system must be installed correctly. Do not use a child restraint with damaged harness straps. Failure to follow these steps can result in serious injury or death.



This restraint is certified for aircraft use when used with the internal harness.

This child restraint is not certified for aircraft use when used as a booster seat because aircraft seats do not have shoulder belts.

Install the child restraint in a window seat to avoid blocking the aisle. If the aircraft lap belt is too short, ask the flight attendant for a belt extender.

Use only on forward-facing aircraft seats. Contact the airline for their specific policies.



Some airlines may ask to see a label stating that this child restraint is certified for aircraft use.

There is an airplane certification label located on the side of this child restraint as shown.

⚠️ Store lower anchor belt and tether strap when installing with aircraft belts.

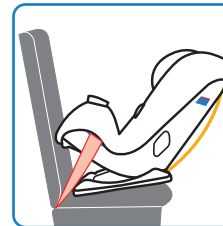

Rear-Facing Aircraft Installation

Follow the steps on pages 27-31.



Forward-Facing Aircraft Installation

Follow the steps on pages 38-41, skipping the tether strap steps.

Replacement and Expiration of Car Seat

Do not risk your child's safety.

To keep your child as safe as possible, Dorel Juvenile Group strongly recommends replacing the car seat even after a minor crash; even if it was not occupied at the time.

Replacement After a Minor Crash

The National Highway Traffic Safety Administration states that for a crash to be considered minor **ALL of the following must be true:**

- Vehicle able to drive away from the crash site; **AND**
- Vehicle door nearest the car seat was not damaged; **AND**
- No passengers were injured; **AND**
- Airbags did not deploy; **AND**
- There is no visible damage to the car seat.

If the crash your car seat was involved in meets **ALL** the criteria, you may not need to replace the car seat.

If one or more of these criteria are not true or if you are uncertain of any of your answers, replace the car seat immediately.

Replacement After a Moderate to Severe Crash

You **must** replace this car seat if it has been in a moderate to severe car crash.

This car seat is intended to protect a child in a single crash. During a crash, the car seat and all of its parts absorb crash energy which can deform or weaken it. Damage is not always visible. A damaged car seat must be replaced immediately.

Expiration



On the side of the child restraint there is a date of manufacture label as shown.

Do not use this child restraint more than 10 years after the date of manufacture.



Child Restraint Use

Never take your child out of the child restraint while the vehicle is moving.

Never leave child unattended. Placing your child in a hot child restraint may result in burns.

Do not use a child restraint with damaged or missing parts.

Do not use a child restraint with cut, frayed or damaged harnesses.

Do not substitute parts or try to modify the child restraint in any way. Do not lubricate buckles and fasteners.

Do not use any child restraint accessory except those approved by Dorel Juvenile Group.

Never allow any child to play with this child restraint; it is not a toy.

Do not remove or cover up any of the warning labels or other labels on the child restraint.

This child restraint has been certified for use in passenger vehicles. Do not use in a boat, on a motorcycle or in a cargo van or bus where there are no seat belts or tether anchors.

Read all instructions for additional warnings.

Installation in Vehicle

Check the vehicle belt or lower anchor belt before each use. Use only if the belt can be tightened properly and locked securely in place.

This child restraint should be securely belted in the vehicle even when not in use. In a crash or sudden stop, an unsecured child restraint could injure occupants.



Vehicle Seating Position



Never place a child rear-facing in a seating position with an active frontal air bag.

Check the vehicle owner's manual for more information about air bag/child restraint use.



Use the child restraint only on vehicle seats that face forward.



Do not use on seats that face the sides or rear of the vehicle.

For vehicles without a back seat, refer to your vehicle owner's manual.



Children are safer when properly restrained in rear seating positions than in the front seating positions.

According to accident statistics, children in rear seating positions are statistically safer, whether you have air bags, advanced air bags, or no air bags at all.

If you are not sure where to place the child restraint in your vehicle: consult your vehicle owner's manual, contact Dorel Juvenile Group Consumer Care Department or visit your local Child Passenger Inspection Station.

Go to <http://www.safercar.gov/cpsApp/cps/index.htm> to find your closest station.

To avoid your child being seriously burned, take the following precautions:

1. Park in the shade or where sun does not directly hit the child restraint.
2. Cover the child restraint with a sheet or blanket when not in use.
3. Check for hot seat and buckles before placing child in child restraint.

To help protect your vehicle seat's upholstery from damage, use a single layer towel underneath and behind child restraint.



Please complete the postage-paid registration card that came with your child restraint, and send it to us. Child restraints could be recalled for safety reasons. You must register this restraint to be reached in a recall. Send your name, address, e-mail address if available and the restraint's model number and manufacturing date to:

Dorel Juvenile Group

2525 State Street
Columbus, IN 47201

or call 1-800-951-4113 or register online at www.djgusa.com/registration/carseat/us.

For recall information, call the U.S. Government's Vehicle Safety Hotline at 1-888-327-4236 (TTY: 1-800-424-9153), or go to <http://www.NHTSA.gov>.

Tear Off and Mail This Part or Register Online / Détachez et postez cette partie ou enregistrez en ligne 4399-4117E

Consumer: Just fill in your name, address and email. Please print.
Client: Simplement inscrire votre nom, adresse et courriel. S.V.P. imprimez.

Your Name/Votre nom:

Your Street Address/Votre adresse:

City/Ville: Province: Postal Code/Code Postal:

Email Address (optional)/Courriel (optionnel):

AB123CDE MAXI-COSI CARSEA 2015/05/16

Date of Purchase/Date d'achat: L#11 B265035

Example of model number, line code, and manufacture date.



If you don't have the card or if your address changes, you will find the model number, manufacture date, and line code on the label located on side of shell.

Dorel Juvenile Group, Inc. (DJG) warrants this product to the original retail purchaser as follows: This product is warranted against defective materials or workmanship for one year from the date of original purchase.

An original receipt is required to validate your warranty.

DJG will, at its option, provide replacement parts or replace this product. DJG reserves the right to substitute if the part or model has been discontinued.

To make a claim under this warranty, please contact our Consumer Care Department by phone: 1-800-951-4113 or text: 1-812-652-2525. Our hours of operation are from 8:00 a.m. to 6:00 p.m. EST Monday through Thursday and from 8:00 a.m. to 4:30 p.m. on Friday.

Proof of purchase is required and shipping charges are the responsibility of the consumer.

Warranty Limitations: This warranty does not include damages which arise from misuse or abuse of this product.

Limitation of Damages: The warranty and remedies as set forth are exclusive and in lieu of all others, oral or written, expressed or implied. In no event will DJG or the dealer selling this product be liable to you for any damages, including incidental or consequential damages, arising out of the use or inability to use this product.

Limitation of warranties and other warranty terms and state law rights: Any implied warranties, including implied warranties of the merchantability and fitness for a particular purpose, shall be limited to the duration and terms of the express written warranty.

Some states do not allow limitations as to how long an implied warranty lasts or the exclusion or limitation of incidental or consequential damages, so the above limitations may not apply to you.

This warranty gives you specific legal rights, and you may have other rights, which vary from state to state. Neither DJG nor the dealer selling this product authorized any person to create for it any other warranty, obligation, or liability in connection with this product.

Please note: Our product warranty only applies when purchased from an authorized Maxi-Cosi retailer. The origin of products not purchased through these authorized retailers is unknown and could be counterfeit.

We cannot support products from an unknown origin as we cannot verify the handling or condition of such merchandise. We maintain a strong network of authorized retailers to ensure you are purchasing safe and complete products.

Fulfillment by a third party does not guarantee you are purchasing from one of these authorized retailers. Pricing which is inconsistent with the majority of retailers is a strong indication that the retailer is not authorized, as we have a consistent price offering across all authorized retailers.

If you are unsure of the authorization status of a retailer you are considering purchasing from, or have purchased from, you can check www.maxi-cosi.com/us-en/shops.aspx; or call our Consumer Care Department at 1-800-951-4113; or text us at 1-812-652-2525.

Troubleshooting

1. If the child restraint buckle or harness release lever sticks or you cannot get the straps tight enough around child:

DO NOT LUBRICATE. Check around lever and retractor for dropped food, sticky spilled drinks, dirt, leaves, etc. Clean with warm water and/or remove object with tweezers. If you cannot get the harness to adjust and remain tight with the buckle securely locked, do not use the child restraint.

2. If your harness twists:

Straighten the harness each time you put your child in the child restraint to help prevent twisting. Lock the buckle and tighten harness so it will be ready for next use.

Buckle Assembly	Lower Anchor Belt
Seat Pad Set	Instructions
ClipQuik™ Chest Clip	Locking Clip
Tether	

**If requested color is not available,
similar color will be substituted.**

Prices are subject to change.

**Applicable tax and shipping &
handling will also be added.**

For parts availability and questions,

Call: 1-800-951-4113

Text: 1-812-652-2525

Chat: www.maxi-cosi.com

If you already know which parts you need,
you may complete your order with a credit card
by calling us at 1-800-951-4113.

We accept Visa or MasterCard.

Hours of Operation:

M-TH from 8:00 AM to 6:00 PM EST
FRI from 8:00 AM to 4:30 PM EST

Thank you for choosing this child restraint. The DJG family is committed to creating child restraints with the most comfort and convenience available today.

Remember, parents are a child's first teachers and examples. If you always buckle your seat belt, your child will think it is the natural thing to do. Make it a firm rule that the vehicle does not go until everyone is buckled up. Make no exceptions.

No one can predict if use of a child restraint will prevent injury or death in a particular crash. However, when combined with careful driving, proper use of a child restraint can lower a child's risk of injury or death in most crashes.

If you still have questions or have any concerns with this child restraint, please contact our Consumer Care Department:

Call: 1-800-951-4113

Text: 1-812-652-2525

Website: www.maxi-cosi.com

Hours of Operation:

M-TH from 8:00 AM to 6:00 PM EST
FRI from 8:00 AM to 4:30 PM EST